

IMPACT



USER MANUAL



SHOP DETECTORS

TEL : +1 206-401-9788

WEB : <https://shopdetectors.com/>

EMAIL : contact@shopdetectors.com

Nakta
DETECTION TECHNOLOGIES

Authorized
R&D CENTER



DEVELOPMENT PROJECT
FUNDED BY THE SCIENTIFIC AND
TECHNOLOGICAL RESEARCH
COUNCIL OF TURKEY

WARNINGS

READ CAREFULLY BEFORE OPERATION OF THE DEVICE

LEGAL DISCLAIMERS

► Comply with applicable laws and regulations governing use of metal detectors while using this detector. Do not use the detector without authorization in protected or archeological sites. Do not use this detector around unexploded ordnance or in restricted military zones without authorization. Notify appropriate authorities with details of any historical or culturally significant artifacts you find.

WARNINGS

- **IMPACT** is a state-of-the-art electronic device. Do not assemble or operate the device before reading the user manual.
- Do not store the device and search coil under extremely low or high temperatures for extended periods. (Storage Temperature: - 20°C to 60°C / - 4°F to 140°F)
- Do not immerse the device or its accessories (except for the search coil) in water. Do not expose equipment to excessively humid environments.
- Protect the detector against impacts during normal use. For shipping, carefully place detector in original carton and secure with shock resistant packaging.
- **IMPACT** metal detector may only be disassembled and repaired by Nokta Authorized Service Centers. Unauthorized disassembly/intrusion into the metal detector control housing for any reason voids the warranty.

IMPORTANT

Do not use the device indoors. The device may constantly give target signals indoors where there are many metals present. Use the device outdoors, in open fields.

Do not let another detector or an electro-magnetic device come in close proximity (10m (30ft.)) to the device.



IMPORTANT

Do not carry any metal objects while using the device. Keep the device away from your shoes while walking. The device may detect the metals on you or inside your shoes as targets.

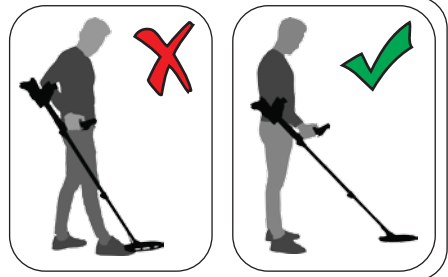

For Consumers within the European Union: Do not dispose of this equipment in general household waste. The crossed wheeled bin symbol on this equipment indicates this unit should not be disposed of in general household waste, but recycled in compliance with local government regulations and environmental requirements.

FCC STATEMENT

This device complies with Part 15 of the FCC Rules. Operation is subject to the following two conditions: (1) this device may not cause harmful interference, and (2) this device must accept any interference received, including interference that may cause undesired operation.

TABLE OF CONTENTS

ASSEMBLY.....	1
INTRODUCTION TO THE DEVICE.....	2
BATTERY INFORMATION.....	3
DISPLAY.....	4
CORRECT USE.....	5
QUICK GUIDE.....	6
GROUND BALANCE.....	7-10
TARGET ID.....	10-11
SEARCH MODES (MODE).....	12-15
SETTINGS.....	16-24
BASIC SETTINGS.....	16-20
EXPERT SETTINGS.....	21-24
PINPOINT.....	25
TARGET DEPTH.....	26
LARGE OR SHALLOW TARGETS.....	26
FALSE SIGNALS AND REASONS.....	26
MAGNETIC MINERALIZATION INDICATOR.....	26-27
ROCKS AND SEARCHING IN ROCKY TERRAINS.....	27-28
TRACKING AND EFFECTS OF ROCKS.....	28
METALS UNDER ROCKS.....	28-29
SEARCHING IN SHALLOW WATER AND BEACH.....	29
MESSAGES.....	30
SOFTWARE UPDATE.....	30
TECHNICAL SPECIFICATIONS.....	31

ASSEMBLY

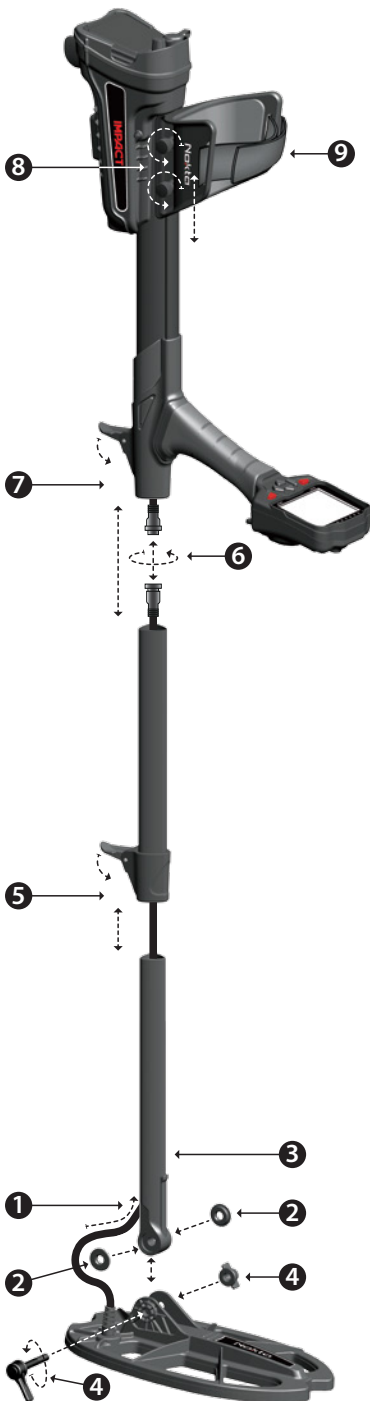

(1) Insert the search coil cable through the hole at the back of the lower shaft.

(2) Insert the washers on the lower shaft yoke.

(3) Insert the lower shaft yoke between search coil mount tabs.

(4) Attach the search coil to the lower shaft using the lever and winged nut without over-tightening.

(5) Fully insert the middle shaft into the lower shaft and push it until it contacts the stopper. Then, secure with the lever latch. If the lower shaft is not inserted fully, the connector at the end of the cable will not come out from the top of the shaft in the next step.

(6) Join the two connectors of the system box cable and coil cable paying attention to the pins, then tighten. The system box cable is a retractable spiral and you can pull it in case you cannot join the two connectors easily.

(7) Join the middle and the upper shafts. Pull the excess cable out of the hole and push the lever latch on the upper shaft to secure. To adjust the shaft length, loosen the lever latch on the middle shaft, adjust the length to your height and press the latch to secure.

(8) To adjust the armrest, loosen the bolts. Slide the armrest up and down to adjust it to your arm and secure by tightening the bolts.

(9) Adjust the armrest strap to your comfort.

INTRODUCTION TO THE DEVICE



BATTERY INFORMATION

The device is supplied with 4 AA Alkaline batteries.

The device can be used for approximately 9-17 hours based on the operating frequency chosen. Battery life will be less in 5kHz compared to other frequencies. Other factors such as LED flashlight usage and usage of speaker or wired/wireless headphones will also affect battery life.

AA Alkaline batteries are recommended for the best performance. Good quality Ni-MH rechargeable batteries can be used, instead. Rechargeable batteries with high mAh (capacity) ratings offer extended operating times versus batteries with lower rating. Do not mix alkaline and rechargeable batteries.

Low Battery Level

Battery icon on the display shows the battery life status. When the charge decreases, the bars inside the battery icon decrease, too. "Lo" message appears on the display when the batteries are depleted.

BATTERY INSTALLATION



Push down on the tabs on both sides and pull the cover up in the direction of the arrow shown in the picture.



Install the batteries, making sure to match the positive and negative ends of the batteries to the correct contacts.



Place the battery cover in the direction of the arrow shown in the picture. Push down on the tabs to get the cover click into its place.

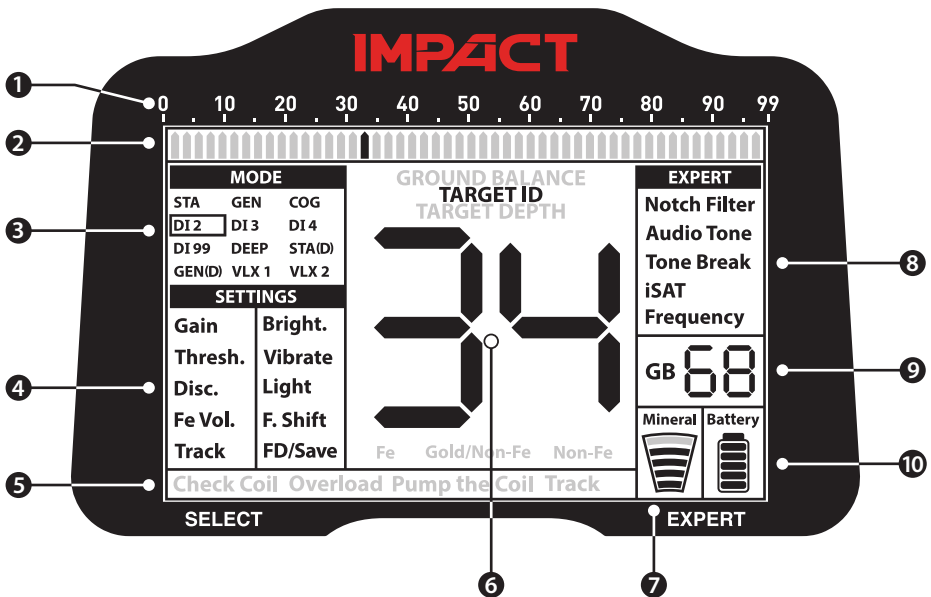

(1) Target ID scale.

(2) Cursor showing the ID of the detected target on the ID scale. It also indicates the IDs filtered by Disc. and Notch Filter settings as well as the tone breakpoints. In the Static modes, it indicates the signal strength.

(3) Search Modes.

(4) Basic Settings.

(5) Section which shows the warning messages.

(6) Section which shows the Target ID upon target detection, the ground balance whole number value during ground balancing and the estimated target depth in the pinpoint mode. In addition, the numeric value of any setting selected from the menu is displayed in this field.

(7) Magnetic mineralization indicator.

(8) Expert Settings.

(9) Section which shows the fine tuning value during ground balance adjustment and current ground balance value during search.

(10) Battery level indicator.

CORRECT USE



Shaft height is wrong

It is very important to adjust the shaft to your height correctly to be able to search without discomfort and fatigue.

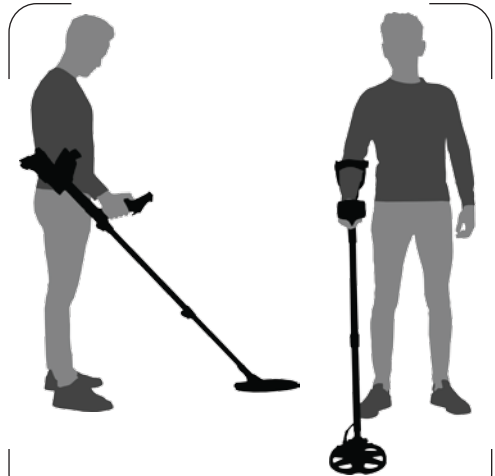

Shaft height is correct

Adjust the height of the shaft so that you are standing in an upright position, your arm is relaxed and the search coil is approximately 5cm (~2") above the ground.

CORRECT WAY OF SWEEPING

Wrong search coil angle



Wrong search coil angle



Correct search coil angle



Incorrect way of sweeping

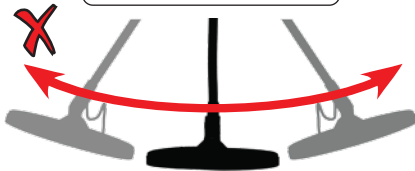

Correct way of sweeping

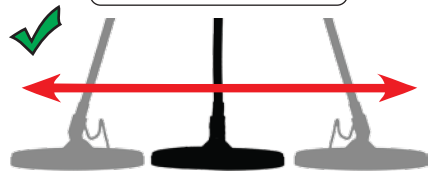

It is important to keep the search coil parallel to the ground in order to get accurate results.

The search coil must be parallel to the ground at all times.

QUICK GUIDE

- 1) Assemble the device as per the instructions on page 1.
- 2) Insert the batteries by paying attention to +/- polarity.
- 3) Rotate the on/off switch located behind the device clockwise to turn on the device. This switch also adjusts the volume of the device as well as the overload volume.
- 4) When the device is turned on, it will start in the DI2 mode and 14kHz operating frequency. You can change the mode and/or the frequency based on ground conditions. For instance, if you are detecting on wet beach sand, you may want to select the COG mode and a different frequency. You can find more details on search modes and frequencies further in this manual.
- 5) To ground balance, push and hold the trigger forward and pump the search coil up and down to 3cm (1.2") above the ground until a "beep" sound is heard.
- 6) You can increase the Gain if needed. Increasing the gain will offer you greater depth. However, if the surroundings or the ground cause excessive noise in the device, you need to lower the gain setting.
- 7) Testing the device with various metals would be helpful for getting familiar with the sounds produced by the device.
- 8) Based on the IDs of the metals you don't want to detect, you can adjust the Disc. setting and ignore those metals. For instance, if you don't want to detect ferrous metals with 00-05 ID in the DI2 mode, you can set the Disc. to 5.
- 9) If you are detecting in a very trashy area and the device is getting too many iron signals, instead of Disc. you can use the Fe Vol. to lower or completely turn off the iron audio. This will provide more depth.
- 10) You can filter out certain Target IDs using the Notch Filter and enable the device to ignore these metals during searching or to provide an iron audio for them.
- 11) If you wish, you can adjust the tone break points of the device with the Tone Break feature and change the frequency of the tones using the Audio Tone setting.
- 12) You can now start searching.
- 13) Since your device operates with the motion principle, swing the search coil right and left maintaining 5cm (2") distance above the ground. If the search coil does not move, the device will not provide any audio responses even if the coil is over a metal target (except for the STATIC modes).
- 14) When a target is detected, the ID of the target will be displayed on the screen and the cursor will indicate its position on the ID scale. (If you wish, you can adjust the ID Depth Level of the device). The device will also produce an audio response according to the search mode selected.
- 15) Upon target detection, you can pinpoint the exact location of the target by pulling and holding the trigger back. The audio volume will increase and the audio pitch will also increase as you approach the target.

GROUND BALANCE

Ground balance can be performed in three ways with the **IMPACT**: Automatic, Manual and Tracking (Track).

If the trigger is pushed forward while performing automatic or manual ground balance, the device will switch to the General Search (GEN) mode automatically on the background without any indication to the user, regardless of the selected search mode.

Upon completion of ground balance, current ground balance value is shown in the Ground Balance (GB) box on the right side of the display.

Automatic Ground Balance

Automatic ground balance is performed as follows in all search modes:

- 1) Find a spot where there is no metal.
- 2) Push the ground balance trigger forward (GROUND BALANCE value and “Pump the Coil” warning message will be shown on display) and start pumping the search coil up and down from about 15-20 cm (~6"- 8") above the ground down to 3 cm (~1") off the ground with smooth movements and keeping it parallel to the ground.

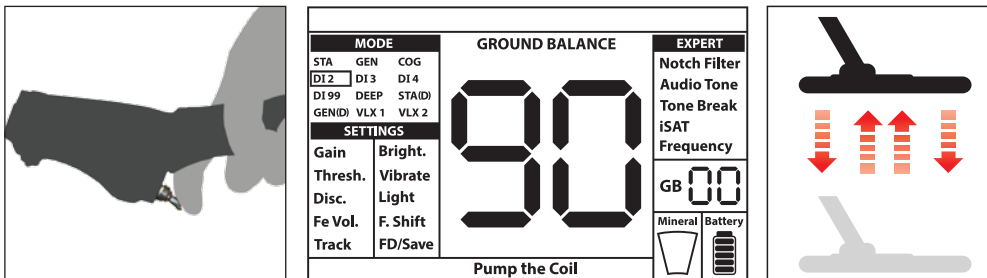

- 3) Continue until a beep, indicating the completion of ground balance, is heard. Based on ground conditions, it usually takes about 2-4 pumps for the ground balance to be completed.
- 4) Upon completion of the ground balance, ground balance value is shown on the display (GB). The device continues to ground balance and produce a beep sound as long as you keep the trigger pushed forward and pump the coil. In order to ensure that the ground balance is proper, ground balance at least 2-3 times and check the ground balance values on the display. In general, the difference between the values shall not be higher than 1-2 numbers.
- 5) If you cannot ground balance, in other words, if no beep sound is produced, it means that either the ground is too conductive or not mineralized or there is a target right below the search coil. In such a case, retry ground balance at a different spot. If you still cannot ground balance, read the section titled “**Important Details Concerning Ground Balance**”.

When the ground balance trigger is released, the device continues to operate in the GEN mode for a short period of time and the ground balance value stays on display. This makes it possible to manually fine tune the automatic ground balance value. Refer to the following “**Manual Ground Balance**” section for further information regarding this feature. If this is not desired, pull and release the trigger once to return to the main screen.

GROUND BALANCE

NOTE: If the iSAT value is set high, the device may not auto ground balance. In such a case, lower the iSAT value first. After ground balancing, set the iSAT back to its original position.

Manual Ground Balance

Allows you to manually modify the ground balance value. It is not preferred mostly because it takes time. However, it is the preferred option in cases where a successful ground balance cannot be performed using other methods or minor corrections are required to the automatic balance.

IMPACT is designed to allow for automatic ground balancing conveniently on any type of ground. Therefore, it is recommended to perform automatic ground balance upon start up. However, the ground may not be suitable for automatic ground balancing in some cases and the device cannot ground balance on such grounds (Except for the COG mode). For instance, wet beach sand, soils containing alkali or salty water, trashy sites, ploughed fields, highly mineralized grounds and grounds with very low mineralization are not suitable for automatic ground balance. In such terrains, you can auto ground balance in the COG mode and then switch to other modes or try manual ground balancing. However, manual ground balance requires a skill which develops over time through practice.

To perform manual ground balance:



- 1) Find a clear spot without metals and switch the device to the GEN mode.
- 2) You need to listen to the sounds coming from the ground in order to perform manual ground balance. Pump the search coil up and down from about 15-20 cm (~6"- 8") above the ground down to 3 cm (~1") off the ground with smooth movements and keeping it parallel to the ground.

If the sound gets higher when lifting off the search coil above the ground, the ground balance value is too low, in other words, the effect from the ground is negative and the ground balance value needs to be increased by using the (+) button. On the other hand, if the sound gets higher when lowering the search coil to the ground, the ground balance value is too high, in other words, the effect from the ground is positive and the ground balance value needs to be decreased by using the (-) button.

- 3) Push the ground balance trigger forward once and release it. The ground balance value will be shown on the display and remain there for a moment. You can return to the ground balance screen by pushing the ground balance trigger forward if the screen switches.

Manual ground balance functions within the range of 0-99. However, each value covers 5 steps used for fine tuning within itself and these steps are indicated as multiples of 20 in the Ground Balance window (GB). For example, ground balance value shown on the side is 70.80.

Press (+) or (-) to increase or decrease the ground balance value, respectively. If the key is pressed once at a time, the values count one by one and if it is held down, the values will change quickly.

MODE		GROUND BALANCE	EXPERT	
STA	GEN COG		70	Notch Filter
D12	D13 D14	Audio Tone		
D199	DEEP STA(D)	Tone Break		
GEN(D)	VLX 1 VLX 2	iSAT		
SETTINGS			Frequency	
Gain	Bright.		GB	80
Thresh.	Vibrate		Mineral	Battery
Disc.	Light			
Fe Vol.	F. Shift			
Track	FD/Save			

4) Repeat the above procedure until the sound heard from the ground is eliminated.

The sound may not be eliminated completely in some areas. In these cases, listen to the sounds produced when moving the search coil towards and away from the ground to check if the ground balance is correct. If there is no difference between the two sounds then the ground balance is set properly.

The device will return to the main screen automatically after a short period of time upon completion of ground balance. To return to the main screen instantly, just pull and release the trigger once.

IMPORTANT! Experienced detectorists adjust the ground balance setting to a slightly positive response (weak but audible sound is produced when moving the search coil closer to ground). This method may produce favorable results for experienced users in certain fields where small targets are searched for.

Ground Tracking (Track)

In this option, the user does not need to make any adjustments. Tracking feature is activated from the menu by switching it to 01 position. The word "Track" is displayed at the bottom of the screen. The device updates the ground balance automatically as long as the search coil is swung over the ground and shows the ground balance value in the GB window. It does not provide any feedback to the user (like the beep sound in automatic ground balance).

While tracking is active, the device can initially produce a loud signal when it detects a different ground structure (for instance a mineral rock) or a target. In this case, swing the search coil over the spot where the device produces the signal. If the sound remains the same and the device shows an ID, it is possibly a target. If the sound attenuates too much or is lost after a few swings, it means that the device has produced a signal for the different ground structure or a stone.

NOTE: It is recommended that you use tracking in the General Search modes (GEN and GEN (D)) and not in the discrimination or static modes.

Tracking is suitable for use in areas where different soil structures are present within the same land or in fields where mineralized rocks are scattered widely apart. If you use ground tracking in areas where hot rocks are intensely present, the device may not be able to eliminate these highly mineralized rocks or you may miss the smaller or deeper metals.

IMPORTANT! Ensure that tracking is off during air tests. Otherwise, the device will attempt to perform ground balance on the target and the depth will be reduced.

Ground Balance Value

Ground balance value provides information about the ground you are searching on. Some typical ground types are as follows:

- 0-25 Wet salt water or wet alkali soils
- 25-50 Wet salt water and wet alkali soils covered with dry layers
- 50-70 Regular, low-quality soils
- 70-90 Highly magnetic soils, magnetite or maghemite and similar highly mineralized soils, black sand.

GROUND BALANCE

Important Details Concerning Ground Balance

1) Upon start up, the ground balance value is set to 90. The device can perform ground balance automatically within the range of 20-90 in all modes and 00-90 in the COG mode.

2) If the ground mineralization is too low, automatic ground balance may fail to work in other modes except for the COG mode. In such a case, you can auto ground balance in the COG mode and then switch to other modes or try manual ground balancing.

3) You can test the accuracy of the ground balance with the pinpoint mode. After ground balancing, if you receive no sound or a weak one when you move the search coil closer to the ground in the pinpoint mode, then the ground balance is successful. If the sound gets louder when you move the search coil closer to the ground, then the ground balance is not successful. In this case, simply change your location. If ground balance is not possible despite these efforts, you should continue your search without performing ground balance.

You cannot search in the General Search and Static modes without ground balancing. You need to use one of the discrimination modes and increase the Disc. value until the noise is eliminated.

4) Once the ground balance is set, it will remain satisfactory for a long time in most areas. However, if you encounter an excavated, backfilled or geologically composite soil structure, a ground balance should be performed again to adapt to the varying soil structure. In addition, re-ground balancing is recommended if you change the operating frequency of the device (5kHz/14kHz/20kHz) in certain ground conditions.

5) When using the optional large coil, pump the coil more slowly and do not keep it very close to the ground.

6) In some cases where the iSAT value is set high, the device may not be able to ground balance automatically. In such a case, first lower the iSAT and after ground balancing switch it back to its previous position.

TARGET ID

TARGET ID is the number produced by the metal detector based on the conductivity of the metals and gives an idea to the user about what the target may be. Target ID is shown with two digits on the display and ranges between 00-99.

NOTE: Keep in mind, large targets will ID higher than expected, even though they may be of lower conductance.

In some cases, the device may produce multiple IDs for the same target. In other words, the IDs may be jumpy. This may result from several factors. Target orientation, depth, purity of the metal, corrosion, mineralization level of the soil etc. Even the direction of the search coil swing may cause the device to generate multiple IDs.

In some cases, the device may fail to provide any ID. The device needs to receive a strong and a clear signal from the target in order to provide an ID. Therefore, it may not be able to provide an ID for targets at fringe depths or smaller targets even if the device detects them.

Keep in mind that target IDs are “probable”, in other words, estimated values and it would not be possible to know the properties of a buried object exactly until it is dug out.

IDs of non-ferrous metals such as copper, silver, aluminum and lead are high. Target ID range of gold is wide and may fall within the same range of metal wastes such as iron, foil, screw caps, and pull tabs. Therefore, if you are looking for gold targets, digging out some trash metals is expected.

IMPACT utilizes 2 different ID scales according to the search modes. In DI2, DI3, DI4, DI99 and COG modes, the ferrous range is 00-15 at factory defaults. In GEN, GEN (D), STA, STA (D), DEEP, VLX1 and VLX2 modes, the ferrous range is 00-40. In addition, when the operating frequency is changed, the Target ID will change as well. This represents the "Standard" ID scaling of the device.

IMPORTANT! At start up, IMPACT will utilize the "Normalized" ID scale and not the Standard ID scale. In other words, the IDs will not change upon frequency change and the device will generate the 14kHz IDs in each frequency. However, based on ground conditions IDs may vary for certain metals.

If you prefer to see the different IDs produced by each frequency, you need use the "Standard" ID scale. To switch to the standard IDs, pull the trigger and push the (+) button at the same time. Letters "Sd" will appear on the screen. If you wish to revert back to the normalized IDs, repeat the same process and letters "no" will appear on the screen.

Tables outlining the search modes and ID ranges as well as the probable IDs for each frequency are placed at the back of this manual. You can easily detach the pages and carry them with you during your searches.

Coins searched throughout the world are made of different metals and in different sizes in different geographical locations and historical eras. Therefore, in order to learn the Target IDs of the coins in a specific region, it is suggested to perform a test with the samples of such coins, if possible.

It may take some time and experience to make best use of the Target ID feature in your search area. Different brands and models of detectors produce different target ID numbers. The numbers vary even more depending on target depth, ground mineralization, and adjacent metals. But after some practice, you will quickly become comfortable with the meanings of the **IMPACT's** Target IDs.

Target ID Depth

This setting is not present in the menu.

Adjusts the depth level that the device displays an ID for a detected target. It consists of 3 levels: Hi (High), In (Intermediate), Lo (Low). Factory default is set to "In".

The lower the ID depth level is, the higher the ID accuracy and vice versa. At the high level, the IDs may become jumpy.

To change the ID depth level, pull the trigger and press the up button simultaneously. Each time you press the up button, the ID depth level will change.

IMPACT has 12 search modes (2 static, 2 all metal and 8 discrimination) designed for different terrains and targets. You can navigate between the modes easily by using the direction buttons. The selected mode name will be framed on screen.

Tables outlining the search modes, recommended areas of usage and settings used in each mode are placed at the back of this manual. You can easily detach the pages and carry them with you during your searches.

Static Mode (STA)

This is a non-motion mode. In other words, the device will generate an audio response when you hold the coil stationary without swinging over the target. The audio response increases in volume as the coil approaches the target. This mode is recommended for larger and deeper metals.

In the STA mode, the device will generate the same audio tone for all metals and it will display the target ID on screen. At the same time, the ID scale will fill up to the right in proportion to the signal strength.

Target ID range is 00-99. 00-40 are ferrous and 41-99 are non-ferrous metals. You can discriminate out all IDs below a certain ID by using the Disc. setting and simply avoid these metals in the field.

When the device detects a discriminated metal, it will not produce an audio response or an ID. However, the ID scale will fill up to the right in proportion to the signal strength.

The threshold in this mode is internal and cannot be adjusted by the user. Changes in the ground and temperature may lead to drifts in the threshold. Threshold drifts will be reflected in the ID scale either in the positive way (right side) or the negative way (left side). The device may emit an audible response in the positive drifts but not in the negative ones. When the threshold drifts, pull the trigger once to retune the detector. Retuning periodically while searching in this mode is recommended.

IMPORTANT! For a more stable operation, try keeping the coil consistently at the same height above the ground where you retuned the detector.

IMPORTANT! If you retune the detector over a target, the threshold will drift to the negative side and the device will no longer detect the target until the detector is retuned. In addition, the depth of the detector will also decrease.

If the drifts are substantial and retuning does not improve the situation, increase the iSAT setting in the Expert Settings to a level where the drifts are eliminated (**for detailed information on iSAT please refer to page 24**). As the iSAT is increased, the device may detect weaker signals but will not be able to detect the targets anymore if you hold the coil stationary or sweep back and forth over the target. If the drifts still continue frequently, drop the gain to 39, decrease the iSAT and re-ground balance.

Static Delta Mode (STA (D))

In principle, it works the same as the static mode. The difference is that the static delta mode

will generate the same tone for ferrous and non-ferrous targets at fringe depths but it will discriminate the shallow ferrous targets by emitting a low iron tone. Also, Disc. setting is not available in this mode.

Please refer to Table 2 at the end of the manual for different settings used in STA and STA (D) modes.

General Search (GEN)

Different than the other modes, this mode features a threshold tone which is continuously heard in the background.

General Search (GEN) mode is used in 2 different ways in the IMPACT: 1) with the Disc. setting disabled at 0 2) with Disc. enabled (non-zero). When the device is first turned on, Disc. setting will be off. When the Disc. is set at 0, the device does not discriminate targets and detects all targets (metals, mineralized rocks etc.). ID of the detected target is shown on the display (except for negative hot rocks) and the same audio tone is provided for all targets. The audio tone increases in pitch as the coil approaches the target. This is the typical All Metal mode found in most detectors.

When using the Disc. Setting in this mode, the device will emit a low ferrous tone for all targets below the Disc. Setting, and a higher tone for all targets above the Disc. setting which changes in pitch as the coil approaches the target. Let's say you set the Disc. to 20. The device will generate a low iron tone for all metals with 0-20 ID and a higher tone for all targets with 21-99 ID. Upon target detection, the threshold will momentarily go silent and only the target audio response will be heard. The duration of the threshold's silence is directly related to the level of the iSAT.

Gain, threshold and iSAT settings in this mode are optimized to provide the best performance on different terrains. You can modify these settings based on ground conditions.

We recommend using the GEN mode when discrimination is not important and not using it in heavy trash areas or areas containing many hot rocks.

Audio Boost in the General Search Mode

This feature is not included in the settings on screen. Boosts the sound of weak signals received from small or deep targets making it easier for you to detect those uncertain targets. It is recommended that audio boost should be used on a temporary or as-needed basis because it will not only boost the target signal audio but it will also boost the volume of ground noise and false signals along with the threshold hum.

Audio Boost consists of 5 levels (b1-b5). At start up, the Audio Boost level is set to low (b1). To increase the Audio Boost level, pull the trigger and press the minus (-) button simultaneously. Audio Boost will only work in the GEN mode.

General Search Delta (GEN (D))

In principle, it works the same as GEN mode. The difference is that the Gen (D) mode will generate the same tone for ferrous and non-ferrous targets at fringe depths but it will discriminate the shallow ferrous targets by emitting a low iron tone.

Please refer to Table 2 at the end of the manual for different settings used in GEN and GEN (D) modes.

2-Tone Discrimination (DI2)

Recommended especially for relic hunting. It produces good results particularly on clean sites which do not contain waste metal. More depth can be obtained on sites which are rocky or those that contain waste metals by using the Disc. and Notch Filter and swinging the search coil more slowly (one right/left pass per approximately 1 second). Disc. is set to 03 as a default value. You can modify this value according to the ID of the targets you don't want to detect.

In this mode, the device produces a low tone for ferrous targets with IDs between 0-15. For targets with IDs 16-99, it produces a higher tone which increases in pitch as the coil approaches the target. By using the Tone Break feature, you can adjust the break points of the target response tones on the Target ID range.

3-Tone Discrimination (DI3)

This is the 3-tone discrimination mode designed for coin hunting especially in trashy sites such as parks. In this mode, the device produces a low tone for ferrous targets with 0-15 IDs, a medium tone for gold and non-ferrous metals with IDs 16-66 and a high tone for non-ferrous metals with IDs 67-99 such as silver, brass and copper. By using the Tone Break feature, you can adjust the break points of the target response tones on the Target ID range.

4-Tone Discrimination (DI4)

4-tone discrimination mode designed for coin hunting in low-medium mineralization. Due to its high gain and depth, this mode is a bit noisier than the other modes. Noise will be more in the air versus in the ground. Take this fact into consideration when adjusting the gain level.

In this mode, the device produces a low tone for ferrous targets with 0-15 IDs, a medium tone for gold and non-ferrous metals with IDs 16-30, a medium-high tone for metals with 31-66 IDs, and a high tone for non-ferrous metals with IDs 67-99. By using the Tone Break feature, you can adjust the break points of the target response tones on the Target ID range.

99-Tone Discrimination (DI99)

Multi-tone discrimination mode designed for coin hunting in various mineralization. In this mode, the device produces a low tone for ferrous targets with 0-15 IDs. For targets with IDs greater than 15, the device will produce a different tone for each ID. The tone will be higher in pitch as the conductivity of the metal increases and vice versa.

Conductive Ground (COG)

This is a special mode of the **IMPACT** developed for conductive grounds (salty wet sand beach, grounds with alkali soil etc.). The feature of this mode presents the ability to ignore iron and similar targets in this group and to be able to perform ground balance on any type of ground. While the device performs ground balance in the range of 20-90 automatically in the other discrimination modes, the device ground balances in the range of 0-90 in this mode. This enables easier ground balancing on conductive grounds where normally ground

balance cannot be performed at all or performed with difficulty.

In this mode, the device produces a low tone for ferrous targets with IDs between 0-15. For targets with IDs 16-99, it produces a higher tone which increases in pitch as the coil approaches the target. By using the Tone Break feature, you can adjust the break points of the target response tones on the Target ID range.

Different than the other modes, the Disc. is set to 15 as a default value in this mode in order to ignore ferrous metals or ground noise.

Salt water and alkali grounds are significantly conductive due to high ionization and cause effects similar to that of iron in detectors. These effects may make it impossible to search for metals with a standard detector. Existence of an iron elimination feature in a detector can improve the situation but may not be sufficient.

IMPACT's COG mode eliminates such effects and ground noise. Aspects to be taken into consideration while searching on conductive grounds are explained in more detail in the section titled Searching in Shallow Water and Beach (page 29).

Deep Mode (DEEP)

Recommended especially for relic hunting, this mode is the deepest mode of the device. Therefore, it may run relatively noisier. Noise will be more in the air versus in the ground. Take this fact into consideration when adjusting the gain level. While searching in this mode, a slower swing speed is required.

The discrimination ability of the DEEP mode is relatively less compared to the other modes. Hence, its performance may vary on trashy sites versus clean ones.

In this mode, the device produces a low tone for ferrous targets with IDs between 0-40. For gold and non-ferrous targets with IDs 41-99, it produces a higher tone which increases in pitch as the coil approaches the target. By using the Tone Break feature, you can adjust the break points of the target response tones on the Target ID range.

VLX1

3-tone discrimination mode designed for users who prefer a lower noise level while detecting. Ideal for coin hunting on changing grounds and different levels of mineralization. It will provide weaker responses for fringe depth targets as well as ground and environmental noises. Therefore, it is suitable for use with Disc. set to 0 and at higher gain levels. If needed, a more stable operation can be obtained by increasing the Disc. but Disc. will create a greater loss in depth in this mode compared to others.

VLX2

Resembles the VLX1 in terms of characteristics. However, it is a deeper mode utilizing 4-tones and it is ideal for both coin and relic hunting in changing ground conditions and all levels of mineralization.

SETTINGS

Tables outlining the settings and the modes they are associated with are placed at the back of this manual. You can easily detach the pages and carry them with you during your searches.

Basic Settings

Push the SELECT button to access the basic settings. You can navigate the basic settings with the up and down buttons. The value of the selected setting will be displayed on screen. You can change the value using the plus (+) and minus (-) buttons. If the up/down and +/- buttons are held down, the options and values will change rapidly.

To exit the settings, press the SELECT button or pull the trigger once. Settings will time out in approximately 8 seconds and the device will revert back to the modes window.

Expert Settings

Push the EXPERT button to access the expert settings. You can navigate the expert settings with the up and down buttons. The value of the selected setting will be displayed on screen. You can change the value using the plus (+) and minus (-) buttons. If the up/down and +/- buttons are held down, the options and values will change rapidly.

To exit the settings, press the EXPERT button or pull the trigger once. Settings will time out in approximately 8 seconds and the device will revert back to the modes window.

NOTE: You can go from basic settings to expert settings directly simply by pressing the EXPERT button. However, you cannot go from expert settings back to basic settings directly. You will need to go back to the modes window first and then push the SELECT button.

NOTE: Certain settings are mode specific and thus cannot be selected in other modes. For details, please review Table 2.

BASIC SETTINGS

GAIN

Gain is the depth setting of the device. It is also used to eliminate the ambient electromagnetic signals from the surrounding environment and noise signals transmitted from ground.

NOTE: To obtain maximum depth performance, to eliminate the noise caused by electromagnetic interference, try shifting the frequency first (F. Shift). If this is not sufficient, change the operating frequency of the device (5kHz/14kHz/20kHz) before lowering the gain.

Gain setting range is 01-99 and pre-defined for each mode. All modes start at default settings. They can be manually modified when necessary. Gain adjustment applies to the selected mode; the modified setting does not affect the gain setting of the other modes.

NOTE: If the ground is highly mineralized causing the device to overload, decrease the gain until the "Overload" message disappears from the screen.

Gain in General Search Modes (GEN and GEN (D))

In the GEN modes, gain setting causes an increase or decrease in the popping sounds and

false signals. Gain setting is a personal preference. However, It is important to set the gain setting to the highest level possible where no major popping sounds are heard to avoid missing smaller and deeper targets. For example; if the noise level is suitable for searching and is the same at gain levels 40 and 70, then 70 should be preferred. Using the factory default levels will be a good starting point until you get familiar and experienced with the device.

Gain in Discrimination Modes:

Since the threshold setting is not available in the discrimination modes, you can increase the depth of the device or ensure noise-free operation on different grounds only by using the gain setting.

In order to adjust the gain in the discrimination modes, first ground balance while the gain is at its default setting. After ground balance is completed, hold the search coil stationary or swing over the ground at search height. Reduce the gain if the device receives noise. If not (ensure that the Disc. is also at its default settings when checking this), increase the gain gradually until there is no popping sound. If the device starts to receive noise during searching, reduce the gain gradually.

NOTE: IMPACT is a high gain device and some of the search modes will run relatively noisy (Deep, DI4, VLX2) compared to other modes so as to provide the best depth performance. However, due to the design characteristics of these modes, the noise will be heard more if the coil is in free air than sweeping the coil on the ground. Please keep this factor in mind while adjusting the gain.

Gain in Static Modes:

The factory default for the gain setting is optimized. In situations where you would like to adjust the gain setting (sudden changes in weather conditions, different ground structures and environmental noise), first re-ground balance. If there are significant positive or negative threshold drifts after ground balancing, increase the iSAT setting in the Expert Settings. If the drifts still continue frequently, drop the gain to 39, decrease the iSAT and re-ground balance.

In situations where the environmental and ground conditions allow, you can obtain more depth by increasing the gain and lowering the iSAT.

Threshold (Thresh.)

In the General Search Modes (GEN and GEN (D)), search is performed with a continuous humming sound in the background, also referred to as the threshold sound. The loudness of this hum directly impacts the detection depth of smaller and deeper targets and it is adjusted by the threshold (Thresh.) setting. If the threshold is set too high, a weak target signal may not be heard. On the contrary, if the threshold is too low, you give up the depth advantage this setting offers. In other words, weak signals of smaller or deeper targets may be missed. It is recommended for average users to leave this setting at its default value and for experienced users to adjust to the highest level where they can still hear the weak target signals.

Threshold level is directly related to the Gain and iSAT settings. Please be sure to read the related sections of the manual carefully.

Discrimination (Disc.)

Disc. is the ability of the device to ignore all metals below a certain Target ID. In the Disc. process, the filtered ID range is shown with lines on the ID scale and every 2 consecutive IDs are represented with 1 line. For example, if you set the Disc. to 30, 15 lines will be shown between the 0-30 ID range on the scale and the device will not produce an audio response for any metals with IDs between 0-30.

Disc. setting is disabled for GEN (D) and STA (D) modes only. For all other modes, the factory default value will be displayed on screen at start up.

In order to change the Disc. value, select the Disc. option from the menu and decrease or increase the value using the plus (+) or minus (-) buttons. Please remember that certain targets, other than the ones you want to ignore, may also be missed or their signals may become weaker when using the Disc. setting.

In the case of receiving multiple IDs for the same target - let's say 35 and 55 - due to the orientation of the target or the composition of the metal itself, if you set the Disc. to 40, because 35 will fall in the filtered range, the signal strength as well as the depth may diminish.

NOTE: Disc. setting works inversely proportional to depth up to level 15 in DI2, DI3, DI4, DI99 and COG modes and up to 49 in GEN, GEN (D), STA, STA (D), DEEP, VLX1 and VLX2 modes. In other words, as the Disc. is increased up to the above mentioned levels, stability will increase but depth will be reduced and vice versa. Above these levels though, both depth and noise will increase.

Iron Volume (Fe Vol.)

It adjusts or turns off the volume of the low iron tone. It can be adjusted between F0-F5 or n1-n5.

F0-F5: F5 is the maximum level. As you lower it, the audio response volume the device produces for ferrous metals will decrease. At F0 level, the iron audio will be silenced. In other words, the device will detect ferrous targets, the Target ID will be displayed on the screen but the device will not produce any audio response.

n1-n5: This will enable you to get a low iron tone for your notched out target IDs instead of silencing them. n5 is the maximum level and the iron volume will be reduced as you go down but it cannot be silenced completely.

Fe Vol. adjustment applies to the selected search mode only. The change does not affect the other modes.

Tracking

When tracking is active (01 position), the device continuously tracks the changing ground structures and automatically reconfigures the ground balance setting. The invisible changes in ground affect the detection depth as well as the discrimination ability of the device so it is possible to operate the device at higher performance using this feature under suitable ground conditions. **Please refer to page 9 for more information on Tracking.**

When tracking is activated, "Track" will be displayed in the message section at the bottom of the screen.

NOTE: Tracking is recommended to be used in the GEN and GEN (D) modes only.

Brightness (Bright.)

It enables you to adjust display backlight level according to your personal preference. It ranges between 0-5 and C1-C5. At 0 level, the backlight is off. When set between 1-5, it lights up only for a short period of time when a target is detected or while navigating the menu and then it goes off. At C1-C5 levels, it will be continuously lit. The continuous operation of the backlight will affect power consumption, which is not recommended.

The backlight setting is restored to the final saved setting when the device is turned off and on again. This setting is common in all modes; change made in any mode also applies to the other modes.

Vibration (Vibrate)

This feature provides feedback to the user by producing a vibration effect when a target is detected. It can be used independently or together with the audio response. When audio response is disabled, all feedbacks are provided to the user as vibration only during target detection.

Vibration setting is adjusted within the range of 00-05. When it is switched to 0, vibration feature is completely disabled. If the vibration is at 01 level, the device provides long vibration signals and at 05 it provides short vibration signals. The magnitude of the vibration effect can vary according to the depth of the target and the swinging speed. This setting is common in all search modes (except for STA and STA (D)); change made in any mode also applies to the other modes. Vibration will not work in STA and STA (D) modes except when the device goes into overload.

Vibration may not be felt in the General Search modes (GEN and GEN (D)) with weak signals; it will be felt as the signal gets stronger. In other words, vibration does not start at the depth where the audio tones are heard but at a lesser depth. Therefore, if you are detecting with vibration only and audio tones are off, you can miss weaker and deeper signals.

Vibration speed is constant in the pinpoint mode and cannot be adjusted. Vibration is off at 0 position. 01-05 values provide the same level of vibration in the pinpoint mode. When vibration is used in the pinpoint mode, vibration speed increases as the target is approached and it reaches the maximum level over the center of the target.

The vibration setting is restored to the final saved setting when the device is turned off and on again. This setting is common in all modes; change made in any mode also applies to the other modes.

Led Flashlight (Light)

It is the headlight used for lighting the area you are scanning while detecting at night or in dark locations. LED flashlight does not operate when the device is off. It is recommended to turn it on only when necessary since its operation consumes extra battery power.

Frequency Shift (F. Shift)

It is used to eliminate the electromagnetic interference that the device receives from another detector which operates in the same frequency range nearby or from the surroundings. If too much noise is received when the search coil is lifted in the air, this may be caused by the local electromagnetic signals or excessive gain settings.

To eliminate the noise caused by electromagnetic interference, try shifting the frequency first (F. Shift) before lowering the gain to obtain maximum depth performance. Frequency shift consists of 5 steps. Default setting is 03 which is the central frequency.

IMPORTANT! Frequency shift may impair performance. Therefore, it is suggested that you do not shift the frequency unless it is necessary. In cases where the interference cannot be eliminated with the frequency shift, the operating frequency of the device ((5kHz/14kHz/20kHz) in the Expert Setting may also be changed.

Factory Default /Save (FD/Save)

With the FD/Save feature of the **IMPACT**, you can save your settings or restore factory defaults. Save function saves all settings except for the ground balance, tracking and light. The device starts in the last mode where the save function was performed.

To save your settings, select FD/Save on screen. Two dashes (--) will be displayed on screen. Push the right button. When "SA" is displayed, press the SELECT button once. You will see lines rotating in the GB window on the right side. When the saving is completed, the lines will stop rotating and the SA text will disappear.

To go back to factory defaults, select FD/Save on screen. Two dashes (--) will be displayed on screen. Push the left button. When "Fd" is displayed, press the SELECT button once. You will see lines rotating in the GB window on the right side. When the process is completed, the lines will stop rotating and the Fd text will disappear.

Notch Filter

Notch Filter is the ability of the device to discriminate single or multiple Target IDs by not emitting an audio response for them or giving a low iron tone (please refer to iron tone in notch filter).

Although Notch Filter may seem similar to Disc. at first glance, these two settings have different functions. While the Disc. filters out all IDs between 0 and the set value, the Notch Filter filters IDs individually.

With the Notch Filter you can reject a single ID or multiple IDs at the same time. This process does not affect any IDs below or above the selected IDs. For example, you can filter out IDs between 31-35 as well as 50 simultaneously.

How To Use The Notch Filter

When Notch Filter is selected from the Expert Settings, first, the current Disc. value will be displayed on screen and discriminated ID range will be shown on the ID scale with lines. For example, if the Disc. is set to 15, when you select Notch Filter, number 15 will be displayed on screen corresponding to 8 lines on the ID scale (every 2 consecutive IDs are represented with 1 line). Notch Filter cannot be used within the Disc. range. In other words, if the Disc. is set to 15, Notch Filter can only be applied to IDs 16 or higher. If you want to Notch Filter IDs 15 or below, first you need to change the Disc. value.

The Notch Filter rejects or accepts IDs with the help of the cursor at the top of the screen. To move the cursor on the scale, plus (+) and minus (-) buttons are used. The cursor blinks while it is moving on the scale. When you are on the first ID that you want to reject, press the SELECT button once. This ID is now rejected and it is shown on the screen with a line. If you want to reject multiple IDs, continue to press the plus (+) or minus (-) button. If non-consecutive IDs want to be rejected, push the SELECT button once to have the cursor blink for navigation on the scale and repeat the process above. The cursor will appear where you left it the next time you use the Notch Filter.

To give an example; let's say you want to reject IDs between 20-25 and the cursor is at 10. Press the plus (+) button until you reach number 20. Then push the SELECT button once. Number 20 will be marked with a line. When you reach number 25 using the (+) button again, IDs between 20-25 will be filtered out and they will be shown on the ID scale with 3 lines (every 2 consecutive IDs are represented with 1 line).

To accept back the filtered IDs, select Notch Filter in the menu. The cursor will appear where you last left it. Using the plus (+) or the minus (-) button, select the ID you want to accept and push the SELECT button. Then, using the plus (+) or minus (-) button again, unfilter the IDs back in. 1 line will be erased for every 2 consecutive IDs accepted.

Iron Tone in Notch Filter:

This will enable you to get a low iron tone for your notched out target IDs instead of silencing them. To use this feature, first select Fe Vol. from the menu and using the plus (+) button select the iron tone volume between n1-n5. n5 is the maximum level and the iron volume will be reduced as you go down but it cannot be silenced completely.

Notch Filter adjustment applies to the selected search mode only. The change does not affect the other modes.

IMPORTANT! If you are using the Standard ID scale and you change the operating frequency of the device, you may need to re-adjust the Notch Filter values according to the IDs you will get in the new frequency.

Audio Tone

Allows you to change the target audio response tones and the threshold sound according to your preference. For each metal group (Fe, Gold/Non-Fe, Non-Fe) the frequency can be adjusted between 150 Hz (15) and 700 Hz (70).

When Audio Tone is selected from the Expert Settings, names of the metal groups mentioned above will appear at the bottom of the screen and the selected one will be framed. To select another group, just press the SELECT button. Then use the plus (+) or the minus (-) button to change the audio frequency.

Audio Tone adjustment applies to the selected search mode only. The change does not affect the other modes.

Tone Break

It is used to adjust the break points of the target response tones on the Target ID range. Default Tone Break points in the **IMPACT** will vary according to the search mode. By using the Tone Break feature, for each metal group (Fe, Gold/Non-Fe, Non-Fe) you can change the point where the low tone changes into the higher tone.

To use the Tone Break feature, first select this setting from the Expert Settings. The names of the metal groups mentioned above will appear at the bottom of the screen. The Tone Break point of the metal group will be shown on the screen numerically while the cursor at the top will point to it on the ID scale. In some modes, there are 2 tone break points and in some there are 3. To select the metal group, just push the SELECT button. Selection will be framed. To change the value of the break point, plus (+) or minus (-) button is used.

To give an example for the above explanation; let's say you are in the DI3 mode and you want to change the Tone Break points. First, select the Tone Break from the Expert Settings. Fe and Gold/Non-Fe will appear at the bottom of the screen and Fe will be framed. The default value of 15 will also be displayed on the screen. Using the plus (+) or the minus (-) button change this number to any value you want. Let's say you increased it to 40. Then, push the SELECT button once to select the Gold/Non-Fe. Let's say you decreased the default value of 66 to 50. In this case, the device will produce a low iron tone for all metals with IDs equal to or less than 40, a medium tone for metals with IDs 41-50 and a high tone for metals with IDs greater than 50 (If you have also adjusted the Audio Tones, the selected frequency will apply to the new ID ranges).

Tone Break adjustment applies to the selected search mode only. The change does not affect the other modes.

IMPORTANT! If you are using the Standard ID scale and you change the operating frequency of the device, you may need to re-adjust the Tone Break points according to the IDs you will get in the new frequency.

iSAT (Intelligent Self-Adjusting Threshold)

iSAT in General Search Modes (GEN and GEN (D))

For the General Search Modes (GEN and GEN (D)) to perform accurately, a stable threshold sound is necessary. You cannot search in the General Search Modes without ground balancing. Changes that occur in the soil structure and mineralization levels after ground balancing, may cause a rise or fall in the background hum and disrupt the threshold's stability which will result in false signals and thus missing signals of small metals. iSAT adjusts the speed that the device recovers its threshold hum and eliminates the negative effects of mineralized soils. Increasing the iSAT in high mineralization will enable a more stable operation by avoiding false signals. This, however, may cause some loss in depth and it is normal.

NOTE: In high mineralization, if you receive too many false signals without disruption in the threshold hum, lower the gain first before increasing the iSAT. If the false signals continue, set the gain back to its original value and increase the iSAT.

If the mineralization is low, you can decrease the iSAT and sweep the coil more slowly for a deeper detection.

iSAT consists of 10 levels. The device will start at level 6. It is recommended that iSAT should be increased in high-mineralization and decreased in low mineralization.

iSAT in Discrimination Modes

It is used to eliminate false signals caused by ground noise or hot rocks when searching in discrimination modes and the available range is between 00-10. Its factory default value is set to (1). You can change the value using the plus (+) and minus (-) buttons.

If the device receives a lot of false signals due to highly mineralized soil or hot rocks in the discrimination modes, first re-ground balance. If the false signals continue, lower the Gain and check again. In case the false signals still exist, try increasing the Disc.value. Regardless of all these, if the false signals still exist, first change the Gain and Disc. values back to their previous levels. Then, increase the iSAT level until the false signals are eliminated.

At the maximum level of iSAT, false signals will disappear or will be minimized. However, in some cases, increasing the iSAT will result in loss of depth for certain metals such as copper.

NOTE: When detecting on wet or highly mineralized ground, in order not to miss smaller high conductive metals (silver, copper etc.) it is recommended not to increase the iSAT level too high.

NOTE: iSAT value ranges between 00-10. The factory default is 01. At "0", the iSAT feature will be inactive. If the ground is not highly mineralized or does not contain many hot rocks, setting the iSAT to "0" is recommended.

iSAT in Static Modes

iSAT in static modes is used to eliminate the threshold drifts caused by changes in the ground and temperature. Threshold drifts will be reflected in the ID scale either in the positive way (right side) or the negative way (left side).

When the threshold drifts, pull the trigger once to retune the detector first. If the drifts are substantial and retuning does not improve the situation, increase the iSAT setting in the Expert Settings to a level where the drifts are eliminated. As the iSAT is increased, the device may detect weaker signals but will not be able to detect the targets anymore if you hold the coil stationary or sweep back and forth over the target.

iSAT value ranges between 0-10. The factory default is 3. At "0", the iSAT feature will be inactive. If the ground and environmental conditions do not cause any drifts in the threshold, setting the iSAT to "0" is recommended.

Frequency

IMPACT offers 3 operating frequencies — 5kHz, 14kHz and 20kHz— to suit different target and soil types.

Based on the frequency selected, the detector's detection performance for different types of targets will vary. The list below includes, but are not limited to, different types of targets that correspond to each frequency:

5kHz: Large ferrous and non-ferrous objects

High conductive coins

Medium or relatively small targets in non-mineralized ground without iron trash

Ferrous masses and militaria

14kHz: General use

Small coins

Different size coins in medium-highly mineralized ground

20kHz: Small coins with different conductivities and thin large coins

Gold coins, rings, small jewelry, sheet iron, foil

Small targets in iron trash

To change the operating frequency of the device, access the Expert Settings simply by pushing the EXPERT Button. After selecting the frequency option, change the frequency using the plus (+) and minus (-) buttons. You will hear the sound of the relay circuit; this is normal. At the same time, lines will start rotating in the GB window and they will stop when the new frequency is active.

Pinpoint is to find the center or the exact location of a detected target.

IMPACT is a motion detector (except for the static modes). In other words, you are required to move the search coil over the target or the target over the search coil in order for the device to detect the target. The pinpoint mode is a non-motion mode. The device continues to give a signal when the search coil is kept stationary over the target.

Ground balance should be performed properly in order to ensure precise pinpointing. It is recommended to perform ground balance again before performing pinpoint operation on changing ground structures.

In the pinpoint mode, estimated target depth is shown on the display. In the pinpoint mode, the signal tone increases in pitch and volume as the search coil approaches the target. In this mode, the device does not discriminate or give target IDs. If the device is in the vibration mode, the speed of vibration will increase as you get closer to the center of target.

To perform pinpoint:

- 1) After a target is detected, move the search coil aside where there is no target response and pull the trigger back.
- 2) Keep the trigger pulled and bring the search coil closer to the target slowly and parallel to the ground.
- 3) Signal sound becomes stronger and changes in pitch while getting closer to the target center and also the number indicating target depth on the display decreases.
- 4) Mark the position which provides the loudest sound using a tool or your foot.
- 5) Repeat the above procedure by changing your direction 90°. Actions to be performed from a couple of different directions will narrow the target area and provide you with the most exact details of the target location.

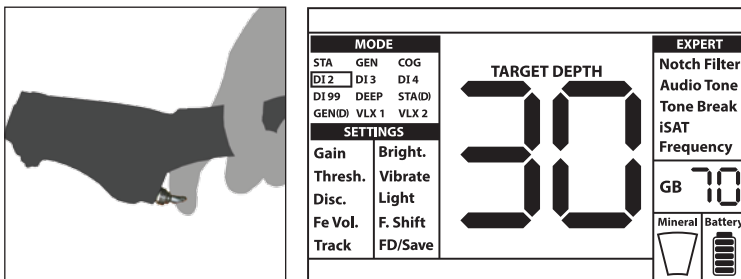

TARGET DEPTH

The device provides an estimated target depth according to the signal strength. In the pinpoint mode, estimated target depth is shown on the display in cms (or inches - please see below for details) while getting closer to the target.

Depth detection is adjusted presuming that the target is a 2.5cm (1") coin. Actual depth varies according to the size of the target. For instance, the detector will indicate more depth for a target smaller than a 2.5cm (1") coin and less depth for a larger target. In reality, pinpoint procedure is not intended for depth determination but exact location determination. Therefore, it is recommended that the depth indicator on the display is used for determining the proximity to the target.

IMPORTANT! If you want the target depth to be displayed in inches instead of cms please do the following: While the device is off, press and hold the SELECT and EXPERT buttons simultaneously and turn the device on. "In" will be displayed. To switch back to cms, you need to turn the device off and then repeat the above procedure. While the device is initializing, "SI" will be displayed.

LARGE OR NEAR-SURFACE TARGETS

Targets which are near the surface may give multiple different signals to the device. If you suspect a target near the surface, lift the search coil and swing it more slowly until a single signal is received. Also, if there is a large target near the surface it may cause an overload in the search coil and the device starts to generate a continuous sound which resembles a siren. "Overload" message is shown on the display simultaneously. In such a case, lift the search coil up until the message disappears.

FALSE SIGNALS AND REASONS

Sometimes, the device may produce signals which are similar to a target signal although no metal target is present. There are various reasons for the false signals received by the device. The most common ones are ground mineralization or rocks with high mineral content, surrounding electromagnetic signals, operation of another nearby detector, rusted or corroded iron or foil in the soil, gain or threshold values set too high.

Surrounding electromagnetic signals can be eliminated by reducing the gain. If another detector is operating nearby, you may attempt to shift the frequency or perform your search at a distance where no interference occurs. If these do not improve the situation, you may try changing the operating frequency (5kHz/14kHz/20kHz) of the device. For ground mineralization or rocks with high mineral content, and gain and threshold set too high, please read the related sections.

MAGNETIC MINERALIZATION INDICATOR

The Magnetic Mineralization Indicator consists of 5 levels. The indicator is shown empty at low mineral levels during search and at start up. In areas where the magnetic mineral level is high, the indicator level increases according to the intensity. This measurement can be summarized as the level of magnetic property and intensity of the ground. Simply, if you are working in an area which contains intense and magnetized minerals, the level will be high. If you are working on a less intense ground, the level will be low.

This measurement is important from two aspects. First, on grounds with high magnetic mineralization, search depth is low and users should be aware of this fact. Second, magnetic mineralization is a property which is particularly seen with mineralized rocks and this measurement plays an important role for the device to eliminate the false signals produced by these rocks.

ROCKS AND SEARCHING IN ROCKY TERRAINS (GENERAL AND DISCRIMINATION MODES)

Challenging ground conditions arise especially when conductivity and magnetic properties of the ground is too intense. Operation of the device over such ground is made possible by selecting the best operating mode and using proper ground balance, gain, iSAT and threshold settings.

Stones and rocks or cavities inside the ground are as important as the ground itself in regards to the search and target detection quality.

Soil and rocks have two different properties just like the targets you are searching for. One of them is the intensity and the other one is the conductivity - magnetic permeability ratio and these two properties are independent from each other. In this manual, the conductivity - magnetic permeability ratio will be referred to as ID in short. High magnetic permeability, low conductivity results in low ID. Soil or rocks can be highly permeable and have low or high IDs as well. If the conductivity increases relatively to magnetic permeability then the ID will also increase.

Hot rocks are classified as negative or positive based on their ID being low or high in comparison to the ID of the soil they are in. One or both of the types may be present in a field. The negative and positive effects mentioned here will only be valid if ground balancing is properly done on the existing ground. Otherwise, soil itself will not act differently from hot rocks in terms of ID. In "Tracking" however, conditions will differ. Therefore, the effects of rocks in tracking will be discussed separately. Here we are referring to a proper ground balance without tracking.

Positive rocks act just like metal and produce a metal sound. In the General Search Modes (GEN and GEN (D)) they produce a "zip zip" sound when the search coil is moved over them. If the signal is strong enough, the device may produce an ID for these rocks. Negative rocks in the General Search modes, produce a long "boing" sound when the search coil is moved over them. The device does not give an ID for these rocks even if the signal is strong.

Positive rocks provide a typical metal sound in discrimination modes. Negative rocks do not provide a sound in discrimination modes (except for rare cases of false signals).

At higher settings of iSAT, there will be no change in the sounds of positive or negative hot rocks. As the iSAT value is decreased, the sound of positive hot rocks will remain the same but the negative hot rocks may give a thinner beep sound instead of the boing sound.

Therefore, you can make a decision by listening to the audio responses produced by the device in the field. If you receive a metal sound, it means that you either detected a positive rock or a piece of metal. If you receive a strong signal and a stable ID, you can distinguish

if the detected target is a rock or metal by checking the ID. However, remember that weak signals may produce different IDs and metals under rocks may produce different metal signals. Therefore, the most appropriate action is to dig up when a metal signal is received.

If you are operating with discrimination modes and you know the ID of the surrounding rocks, you can use the Disc. setting to eliminate the rocks. However, this may not be sufficient to avoid all rock signals. The device may still receive signals from rocks because soil and rocks together will form a combined effect and generate a different ID than those of rocks.

NOTE: In static modes, the device will produce an audio response for the positive rocks but not for the negative ones. The effects of rocks will be reflected on screen as drifts in the right (positive) or left (negative) direction in the ID scale. In the case of a positive drift, there are 2 ways to check whether the target is a rock or not:

- 1) If the ID scale fills up instantly along with the audio and then drops,
- 2) If it does not provide any ID at all or a very low ID, then the target is a rock.

TRACKING AND EFFECTS OF ROCKS

When the tracking is active, the device may give an audio response and ID when it passes over a hot rock because the effect of the rock will be different than the ground's. If you swing the search coil over the rock, tracking will automatically adjust the setting and the audio response/ID will either disappear or diminish significantly. Because there is a slight delay in tracking, you may hear a strong signal at the first one or two swings until the setting is adjusted. Then the sound will get weaker and disappear. This will not happen with metal targets because metals will prevent the device from ground balancing. Therefore, in tracking, if you are getting a constant signal over a target after repeated swings, there is a high possibility that the target is a metal. Moving from over a rock back to soil, the device may give signals to the ground for a few swings until the ground balance setting is updated again. This is normal and should not mislead you.

Tracking is not recommended to eliminate rocks under normal conditions. It is recommended for use in areas with changing soil types.

METALS UNDER ROCKS

IMPACT increases the possibility of detecting metal targets under mineralized rocks through the proper adjustment of your settings. The combined effect created by the rock and metal together is lower than the effect that the metal creates by itself and the displayed ID will be different than the metal's expected ID. The displayed ID is formed by the combination of rock and metal together and gets closer to the ID of the rock if the size of the metal is smaller in relation to the rock. Keep in mind that metals under hot rocks will never appear with their own metal ID. For instance, a gold piece under a brick may produce an iron tone and ID.

Remember this very simple principle as it will save you lots of time: "If the target you detect is not a stone, it can be metal".

The key to detecting targets under mineralized rocks, particularly when positive rocks are in question, is the knowledge of the maximum ID value produced by the surrounding positive

rocks. If you are performing a search in the General Search modes, monitor the ID produced by the device. If the ID provided by your device is close to the rock and iron zone, it is quite possible that you detected a target under the rock. In the case of using Disc. in the GEN mode, all rocks below the Disc. level will produce a low iron tone and all above will produce a higher tone.

If you filter off the rocks with a correctly adjusted ID Disc. setting in discrimination modes, you can hear the signal of the target under the rock if the target signal has a slightly greater effect than the filtered ID. The important thing here is that if you detect a target and dig out a rock, you should note the ID you got before digging and use it as the Disc. value the next time.

For instance; the hot rocks in your search field tend to give IDs around 00-01. In this case, you should set the Disc. to maximum 02. This way you can eliminate rocks and receive the signals of metals underneath. If you set the Disc. too high unnecessarily, you will lose metals along with rocks.

If the hot rocks in your search area tend to give high IDs, then the chances of missing the signals of small metals underneath will be high as well.

SEARCHING IN SHALLOW WATER AND BEACH

All search coils of the **IMPACT** metal detector are waterproof. This provides convenient searching in shallow water and on the beach. When searching around water, be careful not to get the system box wet. This includes the arm cup and control head electronics.

As explained before, salt water and alkali grounds are significantly conductive and cause effects similar to iron in detectors. **IMPACT's** COG mode is specially designed for such conditions. You can perform your search easily using the COG mode without requiring any special settings.

COG mode is ideal for salty wet beach sand. You can use the other modes while performing search over dry beach sand.

You should consider the following while performing search over wet beach sand or water:

- 1) When you swing the search coil over the holes you dig in wet beach sand, you can receive metal signals, this is a normal condition.
- 2) The search coil may give false signals when going into and coming out of the water so please try to keep the coil either in or out of the water.

MESSAGES

Warning messages are shown at the bottom of the display. Messages that may appear are as follows:

Overload

It appears on the display simultaneously with the overload alarm. This happens when the search coil encounters a near surface or a very large object. The device reverts back to normal operation if you lift the coil up. If the alarm and the message continue along a long line, you may be over a long metal such as a pipe.

In case of high mineralization, the device may overload. If the cause of overloading is not a large metal, it may be the ground itself and this situation may be overcome by lowering the gain.

NOTE: You can increase or decrease the overload volume with the on/off button. When the volume of the device is at maximum, the overload volume will be low. As the volume of the device is lowered, the overload volume will increase.

Pump the Coil

This message appears when the trigger is pushed forward for ground balancing. It does not indicate any error or problem. It only indicates what should be done.

Check Coil

It indicates an interruption in the search coil transmitter signal. The search coil connector may be unattached, loose or disconnected. If you own another detector with the same coil connector, please be sure that you have not attached the wrong coil by mistake. If none of the above exists, the search coil or its cable may have a defect. If the issue continues when you change the search coil, there may be an issue in the coil control circuit.

SOFTWARE UPDATE

IMPACT has software update capability. All software updates made after the device is released to the market will be announced on the product's web page along with updating instructions.

System Version Information:

To see the software version of the **IMPACT's** system card and LCD, while the device is **OFF**, press the plus (+) and minus (-) buttons simultaneously and turn the unit on. Continue to hold the buttons depressed until you can read the software version. The major version will be shown in the Target ID section and the minor version in the GB window.

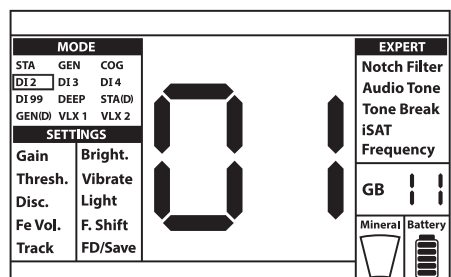

TECHNICAL SPECIFICATIONS

Operating Principle	: VLF
Operating Frequency	: 5kHz/14kHz/20kHz
Audio Frequencies	: 150 Hz - 700Hz adjustable
Search Modes	: 12 (2 Non-motion/2 All Metal/8 Discrimination)
Iron Audio	: Yes
Tone Break	: Yes
Notch Filter	: Yes
Ground Balance	: Automatic / Manual / Tracking
Pinpoint	: Yes
Frequency Shift	: Yes
Vibration	: Yes
Gain Setting	: 01-99
Target ID	: 00-99
Search Coil	: IM28 Waterproof DD 28 x 18 cm (11" x 7")
Display	: Custom LCD
Backlight	: Yes
LED Flashlight	: Yes
Weight	: 1.8 kg (4 lbs.) including search coil and batteries
Length	: 107cm - 143cm (42" - 56 ") adjustable
Battery	: 4 x AA Alkaline
Warranty	: 2 years

Nokta Detectors reserves the right to change the design, specifications or accessories without notice and without any obligation or liability whatsoever.

BUTTON COMBINATIONS	
ID Depth:	Pull the trigger and press the up button
Audio Boost:	Pull the trigger and press the minus (-) button
Standard IDs / Normalization	Pull the trigger and press the plus (+) button
Wireless Headphones	Pull the trigger and press the down button
At Start Up Only	
Cm/Inch	Device off - Press SELECT+EXPERT and turn the device on
Displaying Software Version:	Device off - Press PLUS+MINUS and turn the device on

	TABLE 1 - TARGET IDs						
	ID SCALE (IRON 0-40)			ID SCALE (IRON 0-15)			
	GEN, GEN (D), STA, STA (D), DEEP, VLX1, VLX2			DI2, DI3, DI4, DI99, COG			
	5kHz	14kHz (normal)	20kHz	5kHz	14kHz (normal)	20kHz	
2 Euro	58	71	76	33	52	57	
1 Euro	65	82	84	40	68	75	
Euro 50 Cent	68	83	84	49	70	77	
Euro 20 Cent	64	82	83	40	66	72	
Euro 10 Cent	58	78	82	34	59	67	
US Quarter	83	87	90	72	87	90	
US Nickel	48	55	61	21	30	36	
US Dime	78	85	86	60	78	82	
US Zinc Penny	64	82	83	38	66	71	
US Copper Penny	79	84	86	61	79	84	
US Half Dollar	87	93	95	83	93	95	
US Silver Dollar	90	95	96	88	96	96	
One Pound (1982)	64	82	83	40	67	72	
Two Pounds (2006)	68	83	84	48	71	77	
Fifty Pence (2008)	50	59	66	23	35	44	
Twenty Pence (1982)	51	63	69	24	38	51	
Two Pence (1988)	83	87	89	70	86	90	
Penny (1918)	64	82	83	40	66	71	
1938 Shilling	68	82	84	47	69	75	
1921 Half Crown	83	87	88	70	84	89	
1928 Six Pence	55	72	79	30	53	62	
1868 Six Pence	74	84	85	55	74	79	
1842 Four Pence	68	83	84	49	69	75	
1952 Three Pence	74	84	85	56	74	80	
IMPORTANT! If you are using the "Normalized" ID scale, the device will produce the 14kHz IDs in all frequencies. Some differences may be observed between the frequencies for certain metals and soil conditions.							

TABLE 2 - SETTINGS

SETTINGS	STA		STA (D)		GEN		GEN (D)		DI2		DI3		DI4		DI99		DEEP		COG		VI1		VI2	
	Valid	Default	Valid	Default	Valid	Default	Valid	Default	Valid	Default	Valid	Default	Valid	Default	Valid	Default	Valid	Default	Valid	Default	Valid	Default	Valid	Default
Gain	x	70	x	70	x	70	x	70	x	70	x	70	x	70	x	70	x	70	x	70	x	85	x	85
Thresh.	-	-	-	-	x	55	-	-	-	-	-	-	-	-	-	-	-	-	-	-	-	-	-	-
00-99	-	-	x	00	-	00	-	-	x	03	x	03	x	03	x	03	x	10	x	15	x	00	x	00
Disc.	-	-	-	-	-	-	-	-	x	F5	x	F5	x	F5	x	F5	x	F5	x	F5	x	F5	x	F5
Fe Vol.	-	-	-	-	-	-	-	-	x	00	x	00	x	00	x	00	x	00	x	00	x	00	x	00
Track	x	00	x	00	x	00	x	00	x	00	x	00	x	00	x	00	x	00	x	00	x	00	x	00
Bright.	x	5	x	5	x	5	x	5	x	5	x	5	x	5	x	5	x	5	x	5	x	5	x	5
0-5 / Ct-CS	x	00	x	00	x	00	x	00	x	00	x	00	x	00	x	00	x	00	x	00	x	00	x	00
Vibrate	x	00	x	00	x	00	x	00	x	00	x	00	x	00	x	00	x	00	x	00	x	00	x	00
00-05	x	00	x	00	x	00	x	00	x	00	x	00	x	00	x	00	x	00	x	00	x	00	x	00
Light	x	00	x	00	x	00	x	00	x	00	x	00	x	00	x	00	x	00	x	00	x	00	x	00
00-01	x	03	x	03	x	03	x	03	x	03	x	03	x	03	x	03	x	03	x	03	x	03	x	03
F.Shift	x	03	x	03	x	03	x	03	x	03	x	03	x	03	x	03	x	03	x	03	x	03	x	03
FD/Save	x	-	x	-	x	-	x	-	x	-	x	-	x	-	x	-	x	-	x	-	x	-	x	-
FD/SA	x	-	x	-	x	-	x	-	x	-	x	-	x	-	x	-	x	-	x	-	x	-	x	-
EXPERT																								
Notch Filter	-	-	-	-	-	-	-	-	x	03	x	03	x	03	x	03	x	10	x	15	x	00	x	00
00-99	-	-	-	-	-	-	-	-	x	15-33	x	15-33-64	-	-	-	-	-	x	15-33	x	15-33-64	x	15-33-64	-
Audio Tone	x	33	-	-	x	33	-	-	x	15-33	x	15-33-64	-	-	-	-	-	x	15-33	x	15-33-64	x	15-33-64	-
15-70	-	-	-	-	-	-	-	-	x	40	x	40	x	15-66	x	15-30-66	-	-	x	40	x	40-80	x	40-55-80
00-99	-	-	x	40	-	-	-	-	x	40	x	15-66	x	15-30-66	-	-	-	x	40	x	40-80	x	40-55-80	
Tone Break	-	-	x	40	-	-	-	-	x	40	x	15-66	x	15-30-66	-	-	-	x	40	x	40-80	x	40-55-80	
00-10	x	03	x	03	x	06	x	06	x	01	x	01	x	01	x	01	x	01	x	01	x	01	x	01
ISAT	x	03	x	03	x	06	x	06	x	01	x	01	x	01	x	01	x	01	x	01	x	01	x	01
Frequency	x	14	x	14	x	14	x	14	x	14	x	14	x	14	x	14	x	14	x	14	x	14	x	14
05-14-20	x	14	x	14	x	14	x	14	x	14	x	14	x	14	x	14	x	14	x	14	x	14	x	14
BUTTON COMBOS																								
Lo-In-Hi	x	In	x	In	x	In	x	In	x	In	x	In	x	In	x	In	x	In	x	In	x	In	x	In
ID Depth	x	In	x	In	x	In	x	In	x	In	x	In	x	In	x	In	x	In	x	In	x	In	x	In
Sd-no	x	no	x	no	x	no	x	no	x	no	x	no	x	no	x	no	x	no	x	no	x	no	x	no
ID Normalization	x	no	x	no	x	no	x	no	x	no	x	no	x	no	x	no	x	no	x	no	x	no	x	no
Audio Boost	-	-	-	-	-	-	-	-	-	-	-	-	-	-	-	-	-	-	-	-	-	-	-	
b1-b5	-	-	-	-	-	-	-	-	-	-	-	-	-	-	-	-	-	-	-	-	-	-	-	
WiFi Channel	x	00	x	00	x	00	x	00	x	00	x	00	x	00	x	00	x	00	x	00	x	00	x	00
00-05	x	00	x	00	x	00	x	00	x	00	x	00	x	00	x	00	x	00	x	00	x	00	x	00
Cm-Inch	-	-	-	-	-	-	-	-	-	-	-	-	-	-	-	-	-	-	-	-	-	-	-	
SI - In	-	-	-	-	-	-	-	-	-	-	-	-	-	-	-	-	-	-	-	-	-	-	-	
Software Version	-	-	-	-	-	-	-	-	-	-	-	-	-	-	-	-	-	-	-	-	-	-	-	
SI - In	-	-	-	-	-	-	-	-	-	-	-	-	-	-	-	-	-	-	-	-	-	-	-	

Available at start up only.

* X = Valid setting for this mode

. - = Not valid or applicable

TABLE 3 - MODES

	STA	STA (D)	GEN	GEN (D)	COG	D1Z	D13	D14	D199	DEEP	VLX1	VLX2
GROUND / MINERALIZATION												
TARGET												
COIN												
RELC												
DEEP SILVER												
JEWELRY / GOLD												
DEEP CACHE HUNTING												

"X"= Recommended usage

Blank= Generally less effective usage



Nokta

DETECTION TECHNOLOGIES

www.noktadetectors.com

SHOP DETECTORS
 TEL : +1 206-401-9788
 WEB : <https://shopdetectors.com/>
 EMAIL : contact@shopdetectors.com

